

DROP - TABLA DE DIMENSIONES

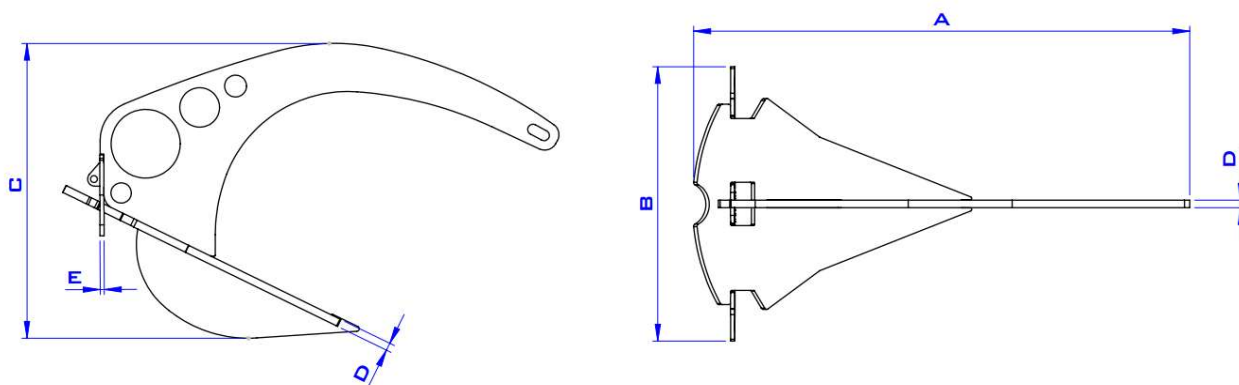

MODELO	MATERIAL	MASA (KG)	GRILLETE	A (MM)	B (MM)	C (MM)	D (MM)	E (MM)
DP6ST	ACERO INOXIDABLE	6,5	∅6	574	320	312	8	4
DP10ST	ACERO INOXIDABLE	10,3	∅6	641	357	348	10	5
DP15ST	ACERO INOXIDABLE	14,9	∅8	774	429	417	10	5
DP21ST	ACERO INOXIDABLE	21,9	∅8	850	475	463	12	6
DP26ST	ACERO INOXIDABLE	25,8	∅8	923	515	502	12	6
DP35ST	ACERO INOXIDABLE	35,7	∅12	969	540	527	15	8
DP40ST	ACERO INOXIDABLE	40,8	∅12	1036	578	564	15	8