

DROP - MEASUREMENTS BOARD

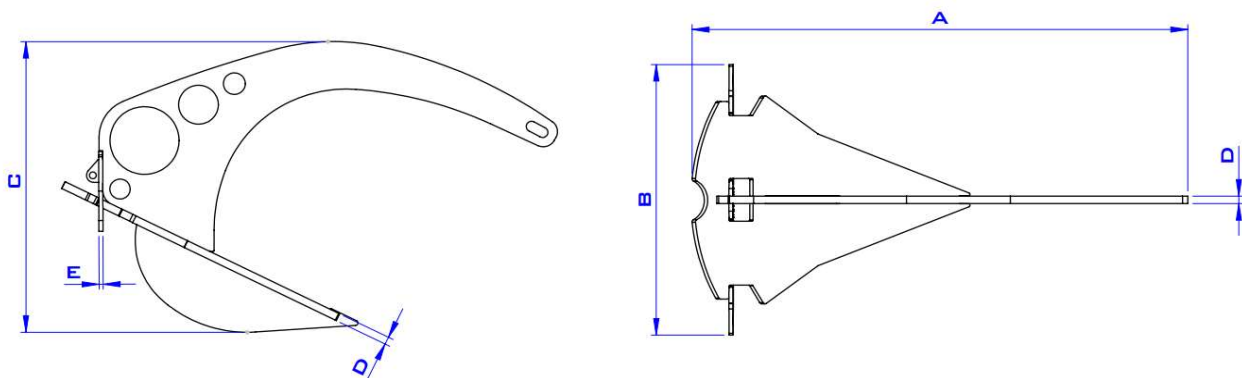

MODEL	MATERIAL	WEIGHT (KG)	SHACKLE	A (MM)	B (MM)	C (MM)	D (MM)	E (MM)
DP6ST	STAINLESS STEEL	6,5	∅6	574	320	312	8	4
DP10ST	STAINLESS STEEL	10,3	∅6	641	357	348	10	5
DP15ST	STAINLESS STEEL	14,9	∅8	774	429	417	10	5
DP21ST	STAINLESS STEEL	21,9	∅8	850	475	463	12	6
DP26ST	STAINLESS STEEL	25,8	∅8	923	515	502	12	6
DP35ST	STAINLESS STEEL	35,7	∅12	969	540	527	15	8
DP40ST	STAINLESS STEEL	40,8	∅12	1036	578	564	15	8